



ELECTRIC DOUBLE OVEN RANGE

Use & Care Guide

For questions about features, operation/performance, parts, accessories or service, call: **1-800-253-1301**.

or visit our website at...
www.whirlpool.com

Table of Contents.....2

**Models
GGE350**

TABLE OF CONTENTS

| | | | |
|---------------------------------------|----------|--------------------------------------|-----------|
| RANGE SAFETY | 3 | OVEN USE | 11 |
| The Anti-Tip Bracket | 4 | Aluminum Foil | 11 |
| COOKTOP USE | 6 | Positioning Racks and Bakeware | 11 |
| Cooktop Controls | 6 | Bakeware | 12 |
| Dual Size Element | 7 | Meat Thermometer | 12 |
| Warm Zone | 7 | Oven Vent | 12 |
| Ceramic Glass | 7 | Baking | 12 |
| Home Canning | 8 | Broiling | 13 |
| Cookware | 8 | Toasting - Upper Oven Only | 14 |
| ELECTRONIC OVEN CONTROLS | 9 | Hold Warm Feature | 14 |
| Display | 9 | Cook & Hold | 14 |
| Cancel | 9 | Automatic Shutoff/Sabbath Mode | 15 |
| Clock | 9 | Favorites | 16 |
| Range Lights | 9 | RANGE CARE | 16 |
| Tones | 9 | Self-Cleaning Cycle | 16 |
| Fahrenheit and Celsius | 10 | General Cleaning | 18 |
| Timer | 10 | Oven Lights | 19 |
| Oven Door and Control Lockout | 10 | Oven Door | 19 |
| 12-Hour Shutoff | 10 | TROUBLESHOOTING | 20 |
| Oven Temperature Control | 10 | ASSISTANCE OR SERVICE | 21 |
| | | WARRANTY | 22 |

RANGE SAFETY

Your safety and the safety of others are very important.

We have provided many important safety messages in this manual and on your appliance. Always read and obey all safety messages.



This is the safety alert symbol.

This symbol alerts you to potential hazards that can kill or hurt you and others.

All safety messages will follow the safety alert symbol and either the word "DANGER" or "WARNING."

These words mean:

⚠ DANGER

You can be killed or seriously injured if you don't immediately follow instructions.

⚠ WARNING

You can be killed or seriously injured if you don't follow instructions.

All safety messages will tell you what the potential hazard is, tell you how to reduce the chance of injury, and tell you what can happen if the instructions are not followed.

The Anti-Tip Bracket

The range will not tip during normal use. However, the range can tip if you apply too much force or weight to the open door without the anti-tip bracket fastened down properly.



⚠ WARNING

Tip Over Hazard

A child or adult can tip the range and be killed.

Connect anti-tip bracket to rear range foot.

Reconnect the anti-tip bracket, if the range is moved.

See the installation instructions for details.

Failure to follow these instructions can result in death or serious burns to children and adults.

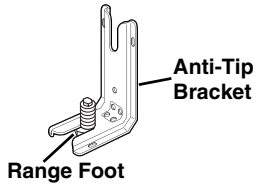

Making sure the anti-tip bracket is installed:

- Slide range forward.
- Look for the anti-tip bracket securely attached to floor or wall.
- Slide range back so rear range foot is under anti-tip bracket.

State of California Proposition 65 Warnings:

WARNING: This product contains a chemical known to the State of California to cause cancer.

WARNING: This product contains a chemical known to the State of California to cause birth defects or other reproductive harm.

IMPORTANT SAFETY INSTRUCTIONS

WARNING: To reduce the risk of fire, electrical shock, injury to persons, or damage when using the range, follow basic precautions, including the following:

- **WARNING:** TO REDUCE THE RISK OF TIPPING OF THE RANGE, THE RANGE MUST BE SECURED BY PROPERLY INSTALLED ANTI-TIP DEVICES. TO CHECK IF THE DEVICES ARE INSTALLED PROPERLY, SLIDE RANGE FORWARD, LOOK FOR ANTI-TIP BRACKET SECURELY ATTACHED TO FLOOR OR WALL, AND SLIDE RANGE BACK SO REAR RANGE FOOT IS UNDER ANTI-TIP BRACKET.
 - **CAUTION:** Do not store items of interest to children in cabinets above a range or on the backguard of a range – children climbing on the range to reach items could be seriously injured.
 - Proper Installation – Be sure the range is properly installed and grounded by a qualified technician.
 - Never Use the Range for Warming or Heating the Room.
 - Do Not Leave Children Alone – Children should not be left alone or unattended in area where the range is in use. They should never be allowed to sit or stand on any part of the range.
 - Wear Proper Apparel – Loose-fitting or hanging garments should never be worn while using the range.
 - User Servicing – Do not repair or replace any part of the range unless specifically recommended in the manual. All other servicing should be referred to a qualified technician.
 - Storage in or on the Range – Flammable materials should not be stored in an oven or near surface units.
 - Do Not Use Water on Grease Fires – Smother fire or flame or use dry chemical or foam-type extinguisher.
 - Use Only Dry Potholders – Moist or damp potholders on hot surfaces may result in burns from steam. Do not let potholder touch hot heating elements. Do not use a towel or other bulky cloth.
 - DO NOT TOUCH SURFACE UNITS OR AREAS NEAR UNITS – Surface units may be hot even though they are dark in color. Areas near surface units may become hot enough to cause burns. During and after use, do not touch, or let clothing or other flammable materials contact surface units or areas near units until they have had sufficient time to cool. Among those areas are the cooktop and surfaces facing the cooktop.
 - Use Proper Pan Size – The range is equipped with one or more surface units of different size. Select utensils having flat bottoms large enough to cover the surface unit heating element. The use of undersized utensils will expose a portion of the heating element to direct contact and may result in ignition of clothing. Proper relationship of utensil to burner will also improve efficiency.
 - Never Leave Surface Units Unattended at High Heat Settings – Boilover causes smoking and greasy spillovers that may ignite.
 - Make Sure Reflector Pans or Drip Bowls Are in Place – Absence of these pans or bowls during cooking may subject wiring or components underneath to damage.
 - Protective Liners – Do not use aluminum foil to line surface unit drip bowls or oven bottoms, except as suggested in the manual. Improper installation of these liners may result in a risk of electric shock, or fire.
 - Glazed Cooking Utensils – Only certain types of glass, glass/ceramic, ceramic, earthenware, or other glazed utensils are suitable for range-top service without breaking due to the sudden change in temperature.
 - Utensil Handles Should Be Turned Inward and Not Extend Over Adjacent Surface Units – To reduce the risk of burns, ignition of flammable materials, and spillage due to unintentional contact with the utensil, the handle of a utensil should be positioned so that it is turned inward, and does not extend over adjacent surface units.
 - Do Not Soak Removable Heating Elements – Heating elements should never be immersed in water.
 - Do Not Cook on Broken Cooktop – If cooktop should break, cleaning solutions and spillovers may penetrate the broken cooktop and create a risk of electric shock. Contact a qualified technician immediately.
 - Clean Cooktop With Caution – If a wet sponge or cloth is used to wipe spills on a hot cooking area, be careful to avoid steam burn. Some cleaners can produce noxious fumes if applied to a hot surface.
 - Use Care When Opening Door – Let hot air or steam escape before removing or replacing food.
 - Do Not Heat Unopened Food Containers – Build-up of pressure may cause container to burst and result in injury.
 - Keep Oven Vent Ducts Unobstructed.
 - Placement of Oven Racks – Always place oven racks in desired location while oven is cool. If rack must be moved while oven is hot, do not let potholder contact hot heating element in oven.
 - DO NOT TOUCH HEATING ELEMENTS OR INTERIOR SURFACES OF OVEN – Heating elements may be hot even though they are dark in color. Interior surfaces of an oven become hot enough to cause burns. During and after use, do not touch, or let clothing or other flammable materials contact heating elements or interior surfaces of oven until they have had sufficient time to cool. Other surfaces of the appliance may become hot enough to cause burns – among these surfaces are oven vent openings and surfaces near these openings, oven doors, and windows of oven doors.
- For self-cleaning ranges –**
- Do Not Clean Door Gasket – The door gasket is essential for a good seal. Care should be taken not to rub, damage, or move the gasket.
 - Do Not Use Oven Cleaners – No commercial oven cleaner or oven liner protective coating of any kind should be used in or around any part of the oven.
 - Clean Only Parts Listed in Manual.
 - Before Self-Cleaning the Oven – Remove broiler pan and other utensils.
- For units with ventilating hood –**
- Clean Ventilating Hoods Frequently – Grease should not be allowed to accumulate on hood or filter.
 - When flambeing foods under the hood, turn the fan on.

SAVE THESE INSTRUCTIONS

COOKTOP USE

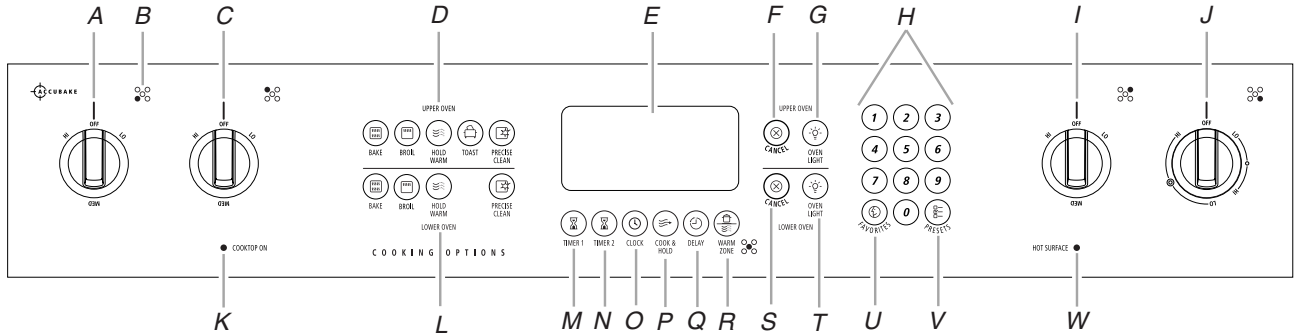

- A. Left front control knob
- B. Surface cooking area locator
- C. Left rear control knob
- D. Upper oven settings
- E. Electronic oven control
- F. Upper oven cancel
- G. Upper oven light
- H. Number pads

- I. Right rear control knob
- J. Right front control knob
- K. Cooktop on indicator light
- L. Lower oven settings
- M. Timer 1
- N. Timer 2
- O. Clock
- P. Cook & hold

- Q. Delay
- R. Warm zone
- S. Lower oven cancel
- T. Lower oven light
- U. Favorites
- V. Presets
- W. Hot surface indicator light

Cooktop Controls

⚠ WARNING



Fire Hazard

Turn off all controls when done cooking.

Failure to do so can result in death or fire.

| SETTING | RECOMMENDED USE |
|------------------|--|
| LO (Low) | <ul style="list-style-type: none"> ■ Keep food warm. ■ Melt chocolate or butter. |
| Warm Zone | <ul style="list-style-type: none"> ■ Keep cooked foods warm. |

REMEMBER: When range is in use or (on some models) during the Self-Cleaning cycle, the entire cooktop area may become hot.

The control knobs can be set anywhere between HI and LO. Push in and turn to setting. Use the following chart as a guide when setting heat levels.

| SETTING | RECOMMENDED USE |
|---------------------------------------|---|
| Dual Elements | <ul style="list-style-type: none"> ■ Large diameter cookware. ■ Large quantities of food. ■ Home canning. |
| HI (High) | <ul style="list-style-type: none"> ■ Bring liquid to a boil. |
| Medium High Between HI and MED | <ul style="list-style-type: none"> ■ Hold a rapid boil. ■ Quickly brown or sear food. |
| MED (Medium) | <ul style="list-style-type: none"> ■ Maintain a slow boil. ■ Fry or sauté foods. ■ Cook soups, sauces and gravies. |
| Medium Low Between MED and LO | <ul style="list-style-type: none"> ■ Stew or steam food. ■ Simmer. |

Cooktop On Indicator Light

A cooktop On Indicator Light is located on the control panel. When any surface element is turned on, the light will glow.

Hot Surface Indicator Light

A hot surface indicator light is located on the control panel. The hot surface indicator light will glow as long as any surface cooking area is too hot to touch, even after the surface cooking area(s) is turned off.

Dual Size Element

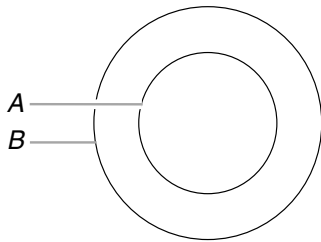

A. Single size
B. Dual size

The dual size elements offer flexibility to cook using different sizes of cookware. The single element can be used in the same way as a regular element. The dual element combines both the inner and outer elements and is recommended for larger cookware.

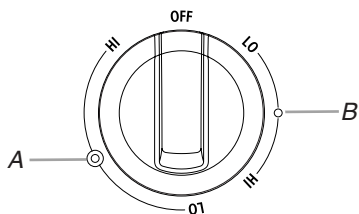

A. Dual element control - left side
B. Single element control - right side

To Use Single Element:

1. Push in and turn the control knob counterclockwise from the OFF position to the Single zone anywhere between HI and LO.
2. Push in and turn knob to OFF when finished.

To Use Dual Element:

1. Push in and turn the control knob clockwise from the OFF position to the Dual zone anywhere between HI and LO.
2. Push in and turn knob to OFF when finished.

Warm Zone

! WARNING

Food Poisoning Hazard

Do not let food sit for more than one hour before or after cooking.

Doing so can result in food poisoning or sickness.

Use the Warm Zone element to keep cooked foods warm. One hour is the recommended maximum time to maintain food quality.

Do not use it to heat cold foods.

The Warm Zone element can be used alone or when any of the other surface cooking areas are being used.

The Warm Zone element area will not glow red when cycling on. However, the Element On light will glow while the Warm Zone element is in use. The Hot Surface light will glow as long as the Warm Zone element area is too hot to touch.

- Use only cookware and dishes recommended for oven and cooktop use.
- Cover all foods with a lid or aluminum foil. When warming baked goods, allow a small opening in the cover for moisture to escape.
- To avoid damage to the cooktop, do not use plastic wrap to cover food because the plastic wrap may melt.
- Use pot holders or oven mitts to remove food.



To Use:

1. To turn on, press WARM ZONE and then PRESETS.
2. To turn off, press WARM ZONE.

Ceramic Glass

The surface cooking area will glow red when an element is on. It may cycle on and off to maintain the selected heat level.

It is normal for the surface of light colored ceramic glass to appear to change color when surface cooking areas are hot. As the glass cools, it will return to its original color.

Cleaning off the cooktop before and after each use will help keep it free from stains and provide the most even heating. On cooktops with light colored ceramic glass, soils and stains may be more visible, and may require more cleaning and attention. Cooktop cleaner and a cooktop scraper are recommended. For more information, see "General Cleaning" section.

- Avoid storing jars or cans above the cooktop. Dropping a heavy or hard object onto the cooktop could crack the cooktop.
- To avoid damage to the cooktop, do not leave a hot lid on the cooktop. As the cooktop cools, air can become trapped between the lid and the cooktop, and the ceramic glass could break when the lid is removed.
- For foods containing sugar in any form, clean up all spills and soils as soon as possible. Allow the cooktop to cool down slightly. Then, while wearing oven mitts, remove the spills using a scraper while the surface is still warm. If sugary spills are allowed to cool down, they can adhere to the cooktop and can cause pitting and permanent marks.
- To avoid scratches, do not slide cookware or bakeware across the cooktop. Aluminum or copper bottoms and rough finishes on cookware or bakeware could leave scratches or marks on the cooktop.
- Do not cook popcorn in prepackaged aluminum containers on the cooktop. They could leave aluminum marks that cannot be removed completely.
- To avoid damage to the cooktop, do not allow objects that could melt, such as plastic or aluminum foil, to touch any part of the entire cooktop.
- To avoid damage to the cooktop, do not use the cooktop as a cutting board.

- Use cookware about the same size as the surface cooking area. Cookware should not extend more than ½" (1.3 cm) outside the area.

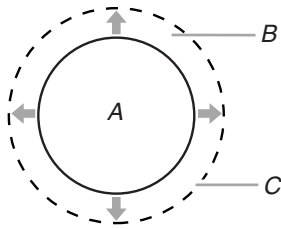

A. Surface cooking area
 B. Cookware/canner
 C. ½" (1.3 cm) maximum overhang

- Use flat-bottomed cookware for best heat conduction and energy efficiency. Cookware with rounded, warped, ribbed or dented bottoms could cause uneven heating and poor cooking results.
- Determine flatness by placing the straight edge of a ruler across the bottom of the cookware. While you rotate the ruler, no space or light should be visible between it and the cookware.
- Cookware designed with slightly indented bottoms or small expansion channels can be used.
- Make sure the bottoms of pots and pans are clean and dry before using them. Residue and water can leave deposits when heated.
- To avoid damage to the cooktop, do not cook foods directly on the cooktop.

Home Canning

When canning for long periods, alternate the use of surface cooking areas, elements or surface burners between batches. This allows time for the most recently used areas to cool.

- Center the canner on the grate or largest surface cooking area or element. On electric cooktops, canners should not extend more than ½" (1.3 cm) beyond the surface cooking area or element.
- Do not place canner on 2 surface cooking areas, elements or surface burners at the same time.
- On ceramic glass models, use only flat-bottomed canners.
- For more information, contact your local agricultural department. Companies that manufacture home canning products can also offer assistance.

Cookware

IMPORTANT: Do not leave empty cookware on a hot surface cooking area, element or surface burner.

Ideal cookware should have a flat bottom, straight sides and a well-fitting lid, and the material should be of medium-to-heavy thickness.

Rough finishes may scratch the cooktop or grates. Aluminum and copper may be used as a core or base in cookware. However, when used as a base they can leave permanent marks on the cooktop or grates.

Cookware material is a factor in how quickly and evenly heat is transferred, which affects cooking results. A nonstick finish has the same characteristics as its base material. For example, aluminum cookware with a nonstick finish will take on the properties of aluminum.

Cookware with nonstick surfaces should not be used under the broiler.

Use the following chart as a guide for cookware material characteristics.

| COOKWARE | CHARACTERISTICS |
|---|--|
| Aluminum | <ul style="list-style-type: none"> ■ Heats quickly and evenly. ■ Suitable for all types of cooking. ■ Medium or heavy thickness is best for most cooking tasks. |
| Cast iron | <ul style="list-style-type: none"> ■ Heats slowly and evenly. ■ Good for browning and frying. ■ Maintains heat for slow cooking. |
| Ceramic or Ceramic glass | <ul style="list-style-type: none"> ■ Follow manufacturer's instructions. ■ Heats slowly, but unevenly. ■ Ideal results on low to medium heat settings. |
| Copper | <ul style="list-style-type: none"> ■ Heats very quickly and evenly. |
| Earthenware | <ul style="list-style-type: none"> ■ Follow manufacturer's instructions. ■ Use on low heat settings. |
| Porcelain enamel-on-steel or cast iron | <ul style="list-style-type: none"> ■ See stainless steel or cast iron. |
| Stainless steel | <ul style="list-style-type: none"> ■ Heats quickly, but unevenly. ■ A core or base of aluminum or copper on stainless steel provides even heating. |

ELECTRONIC OVEN CONTROLS

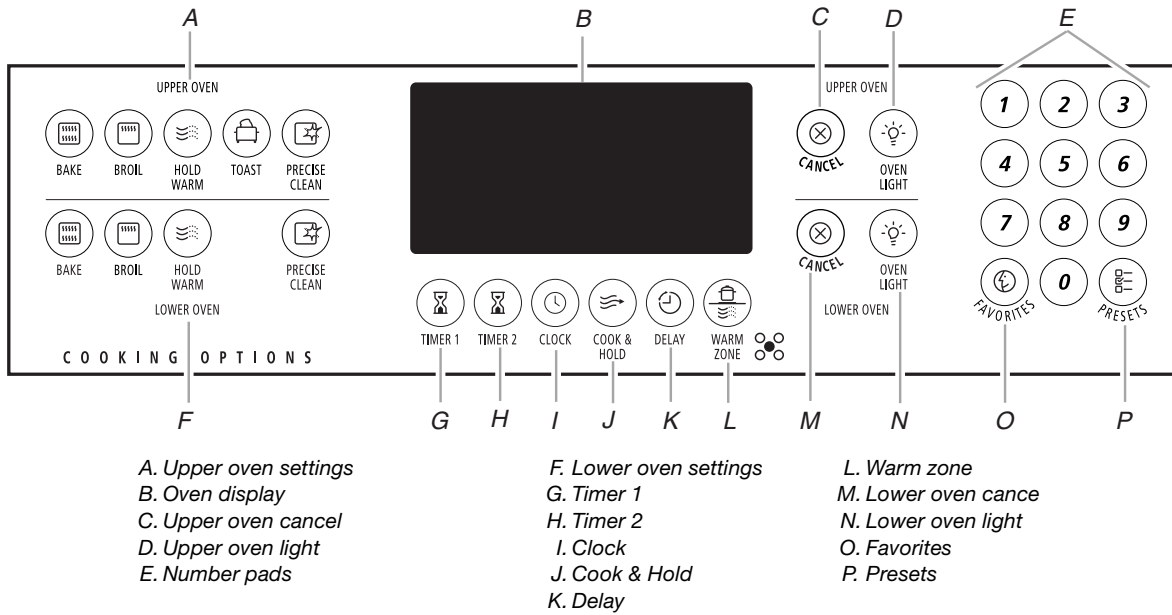

A. Upper oven settings
 B. Oven display
 C. Upper oven cancel
 D. Upper oven light
 E. Number pads

F. Lower oven settings
 G. Timer 1
 H. Timer 2
 I. Clock
 J. Cook & Hold
 K. Delay

L. Warm zone
 M. Lower oven cancel
 N. Lower oven light
 O. Favorites
 P. Presets

Display

When power is first supplied to the appliance, a flashing time will appear on the display. See "Clock" section to set time of day.

If a flashing time appears at any other time, a power failure has occurred. Press CANCEL and reset the clock if needed.

When the oven is not in use, the display shows the time of day.

Cancel

The Cancel pad stops any function except the Clock, Timer, and Control Lock.

Clock

The clock can be set to display time in a 12-hour or 24-hour format. The clock is set at the factory for the 12-hour format.

To change the clock to 24-hour format:

1. Press and hold the upper oven CANCEL pad and FAVORITE pad for 3 seconds. "12 Hr" will flash in the display.
2. Press PRESETS to select "24 Hr"; press again to select "12 Hr."
3. Set the time of day by following the "To Set" instructions.

To Set:

Before setting, make sure the oven and Timer are off.

1. Press CLOCK. The time of day and colon flash in the display.
2. Press the number pads to set the time of day.
3. Press CLOCK again or wait 4 seconds. The colon will remain on.

To recall the time of day when another time function is showing, press CLOCK.

To Cancel:

Press and hold upper oven CANCEL and CLOCK for 3 seconds. The time of day will disappear from the display.

When the clock display is canceled, press CLOCK to briefly display the time of day.

To Restore:

Press and hold upper oven CANCEL and CLOCK for 3 seconds. The time of day will reappear from the display.

Range Lights

Oven Lights

While the oven door is closed, press UPPER or LOWER OVEN LIGHT to turn the light on and off. The oven light will come on when the oven door is opened. The oven light will not come on during the Self-Clean cycle.

Tones

Tones are audible signals, indicating the following:

Basic Functions

One tone

- Valid pad press
- Oven is preheating (long tone)
- Function has been entered

Two tones

- Invalid pad press

Four tones

- End of cycle

Adjusting Sound Level

The oven is factory set for medium (MEd) but can be changed to low (LO) or high (HI).

1. Press and hold DELAY and UPPER CANCEL for 3 seconds. A beep will sound. "bEEP" and the current sound level will be displayed.
2. Press PRESETS to increase or decrease the sound level. Wait 4 seconds for the new setting to be accepted.

If PRESETS is not pressed within 30 seconds, the control will return to the existing setting.

Fahrenheit and Celsius

The temperature is preset at Fahrenheit, but can be changed to Celsius.

1. Press and hold the upper oven BAKE and CANCEL pads for 3 seconds. A beep will sound, and the current setting (°F or °C) will appear in the display.
2. Press PRESETS to change the setting. Wait 4 seconds for the new setting to be accepted.

If PRESETS is not pressed within 30 seconds, the control will return to the existing setting.

Timer

Each Timer can be set in hours or minutes up to 99 hours and 59 minutes, and counts down the set time. The Timer does not start or stop the oven.

To Set:

1. Press TIMER 1 or TIMER 2.
"00:00" and "TIMER 1" or "TIMER 2" will flash in the display.
2. Press the number pads to select the desired time.
The colon and "TIMER 1" or "TIMER 2" will continue to flash. If both timers are active, "TIMER 1" and "TIMER 2" will be displayed.
3. Press TIMER 1 or TIMER 2 again or wait 4 seconds. The colon stops flashing, and the time begins counting down.
The last minute of the timer countdown will be displayed in seconds.
At the end of the set time, one long beep will sound and "End" will be displayed.
4. Press TIMER to clear the display.

To Cancel:

Press and hold Timer pad for 3 seconds or press the Timer pad and "0" using the number pads.

Oven Door and Control Lockout

The oven door and controls can be locked out to avoid unintended use of the oven.

The oven doors and controls cannot be locked if the oven is in use, or the oven temperature is 400°F (205°C) or above.

The current time of day will remain in the display when the controls and oven doors are locked.

To Lock Controls and Both Oven Doors:

1. Press and release CANCEL.
2. Press and hold upper oven CANCEL and COOK & HOLD for 3 seconds. "OFF" appears in the display and "LOCK" flashes while the controls and oven doors are locking.
Both oven doors lock. "LOCK" remains lit in the display.

To Unlock Controls and Both Oven Doors:

1. Press and hold upper oven CANCEL and COOK & HOLD for 3 seconds. "OFF" disappears from the display and "LOCK" flashes while the controls and oven doors are unlocking.

12-Hour Shutoff

The oven control is set to automatically shut off the oven 12 hours after the oven turns on. This will not interfere with any timed or delayed cook function.

To cancel the 12-hour shutoff function and enable Sabbath Mode, see the "Sabbath Mode" section.

Oven Temperature Control

IMPORTANT: Do not use a thermometer to measure oven temperature because opening the oven door may cause burner cycling to give incorrect readings.

The oven provides accurate temperatures; however, it may cook faster or slower than your previous oven, so the temperature calibration can be adjusted. It can be changed in Fahrenheit or Celsius.

A minus sign means the oven will be cooler by the displayed amount. The absence of a minus sign means the oven will be warmer by the displayed amount. Use the following chart as a guide.

| ADJUSTMENT °F (ADJUSTMENT °C) | COOKS FOOD |
|----------------------------------|--------------------|
| 10°F (5°C) | ...a little more |
| 20°F (10°C) | ...moderately more |
| 30°F (15°C) | ...much more |
| -10°F (-5°C) | ...a little less |
| -20°F (-10°C) | ...moderately less |
| -30°F (-15°C) | ...much less |

To Adjust Oven Temperature Calibration:

1. Press the appropriate BAKE pad.
2. Enter 550 using the number pads.
3. Press and hold BAKE for several seconds or until 00° appears in the display.

If the oven temperature was previously adjusted, that change will appear in the display. For example, if the oven temperature was previously reduced by 15°F, the display will show “-15°.”

4. Press PRESETS to increase or decrease the temperature in 5° (3°C) amounts. The adjustment can be set between 35°F (21°C) and -35°F (-21°C).
5. The time of day will automatically appear in the display.

OVEN USE

Odors and smoke are normal when the oven is used the first few times, or when it is heavily soiled.

IMPORTANT: The health of some birds is extremely sensitive to the fumes given off. Exposure to the fumes may result in death to certain birds. Always move birds to another closed and well-ventilated room.

Aluminum Foil

IMPORTANT: To avoid permanent damage to the oven bottom finish, do not line the oven bottom with any type of foil or liner.

- For best cooking results, do not cover entire rack with foil because air must be able to move freely.
- To catch spills, place foil on rack below dish. Make sure foil is at least ½" (1.3 cm) larger than the dish and that it is turned up at the edges.

Positioning Racks and Bakeware

IMPORTANT: To avoid permanent damage to the porcelain finish, do not place food or bakeware directly on the oven door or bottom.

RACKS

- Position racks before turning on the oven.
- Do not move racks with bakeware on them.
- The upper oven is equipped with 1 rack.
- Make sure racks are level.

To Replace Oven Racks:

Place rack on the rack support in the oven. Tilt the front edge up slightly, and slide rack back until it clears the stop position. Lower front and slide back into the oven.

To Remove Oven Racks:

Pull rack out to the stop position, raise the front edge, then lift out.

Rack Positions

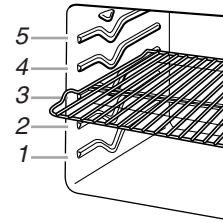

| FOOD | RACK POSITION |
|---|---------------|
| Large roasts, turkeys, angel food, bundt and tube cakes, quick breads, pies | 1 or 2 |
| Yeast breads, casseroles, meat and poultry | 2 |
| Cookies, biscuits, muffins, cakes | 2 or 3 |
| 2-rack baking and broiling | 4 |
| Toasting bread or broiling very thin foods and 2-rack baking. | 5 |

BAKEWARE

Hot air must be able to circulate around food to cook evenly, so allow 2" (5 cm) of space around bakeware and oven walls. Use the following chart as a guide.

| NUMBER OF PAN(S) | POSITION ON RACK |
|------------------|---|
| 1 | Center of rack. |
| 2 | Side by side or slightly staggered. |
| 3 or 4 | Opposite corners on each rack. Make sure that no bakeware piece is directly over another. |

Bakeware

The bakeware material affects cooking results. Follow manufacturer's recommendations and use the bakeware size recommended in the recipe. Use the following chart as a guide.

| BAKEWARE/ RESULTS | RECOMMENDATIONS |
|--|--|
| Light colored aluminum <ul style="list-style-type: none"> ■ Light golden crusts ■ Even browning | <ul style="list-style-type: none"> ■ Use temperature and time recommended in recipe. |
| Dark aluminum and other bakeware with dark, dull and/or nonstick finish <ul style="list-style-type: none"> ■ Brown, crisp crusts | <ul style="list-style-type: none"> ■ May need to reduce baking temperatures slightly. ■ Use suggested baking time. ■ For pies, breads and casseroles, use temperature recommended in recipe. ■ Place rack in center of oven. |
| Insulated cookie sheets or baking pans <ul style="list-style-type: none"> ■ Little or no bottom browning | <ul style="list-style-type: none"> ■ Place in the bottom third of oven. ■ May need to increase baking time. |
| Stainless steel <ul style="list-style-type: none"> ■ Light, golden crusts ■ Uneven browning | <ul style="list-style-type: none"> ■ May need to increase baking time. |
| Stoneware/Baking stone <ul style="list-style-type: none"> ■ Crisp crusts | <ul style="list-style-type: none"> ■ Follow manufacturer's instructions. |
| Ovenproof glassware, ceramic glass or ceramic <ul style="list-style-type: none"> ■ Brown, crisp crusts | <ul style="list-style-type: none"> ■ May need to reduce baking temperatures slightly. |

Meat Thermometer

On models without a temperature probe, use a meat thermometer to determine whether meat, poultry and fish, are cooked to the desired degree of doneness. The internal temperature, not appearance, should be used to determine doneness. A meat thermometer is not supplied with this appliance. Follow manufacturer's directions for using a meat thermometer.

Oven Vent

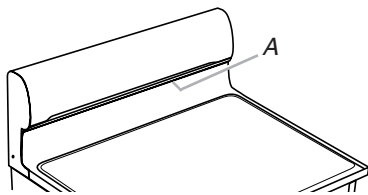

A. Oven vent

The oven vent releases hot air and moisture from the oven, and should not be blocked or covered. Blocking or covering the vent will cause poor air circulation, affecting cooking and cleaning results. Do not set plastics, paper or other items that could melt or burn near the oven vent.

Baking

Before baking, position racks according to the "Positioning Racks and Bakeware" section.

- If the lower oven is not in use, the upper oven will preheat more quickly.
- Allow at least ½" (1.3 cm) between the baking pan or casserole and the top element in the upper oven. Loaf, angel food or bundt pans are not recommended in the upper oven.
- When baking frozen, self-rise pizza in the upper oven, place the pizza on a cookie sheet to avoid overbrowning.
- When preheating with a baking/pizza stone inside the upper oven, do not set oven above 400°F (205°C). To use baking/pizza stones at temperatures above 400°F (205°C) in the upper oven, put stone in after the preheat beep.
- The back part of the lower oven bake element will not glow red during baking. This is normal.

To Bake or Roast:

1. Press the BAKE keypad for desired oven. "BAKE" and "000" will flash in the display.
2. Select the oven temperature. Press PRESETS for 350°F (175°C) or the appropriate number pads. Each additional press of the Presets pad will increase the temperature by 25°F (15°C).

The oven temperature can be set between 170°F and 550°F (75°C and 288°C).

3. Press BAKE again or wait 4 seconds. "BAKE" will stop flashing and light in the display. PREHEAT will light in the display. 100°F (35°C) or the actual oven temperature if over 100°F (35°C) will display. The temperature will rise in 5° increments until the preset temperature is reached.

Allow 4 to 10 minutes for the upper oven to preheat and 7 to 12 minutes for the lower oven to preheat.

When the set oven temperature is reached, one long beep will sound and "PREHEAT" will disappear from the display.

To recall the set temperature during preheat, press BAKE.

To change the oven temperature during preheat, press the Bake pad twice, then press the Presets pad or appropriate number pads until the desired temperature is displayed.

4. Place food in the oven. To change the oven temperature during cooking, press Bake, then press the Presets or appropriate number pads until the desired temperature is displayed.
5. Press CANCEL when finished.
6. Remove food from the oven.

Broiling

Broiling uses direct radiant heat to cook food. The lower the temperature, the slower the cooking. Thicker cuts and unevenly shaped pieces of meat, fish and poultry may cook better at lower broiling temperatures.

- For best results, use a broiler pan and grid (provided on some models). It is designed to drain juices and help avoid spatter and smoke.

If you would like to purchase a broiler pan, one may be ordered. See “Assistance or Service” section to order. Ask for Part Number 4396923.

- For proper draining, do not cover the grid with foil. The bottom of the pan may be lined with aluminum foil for easier cleaning.
- Trim excess fat to reduce spattering. Slit the remaining fat on the edges to avoid curling.
- Select HI broil for most broiling. Select LO broil for low-temperature broiling of longer cooking foods such a poultry to avoid overbrowning.
- Pull out oven rack to stop position before turning or removing food. Use tongs to turn food to avoid the loss of juices. Very thin cuts of fish, poultry or meat may not need to be turned.

- After broiling, remove the pan from the oven when removing the food. Drippings will bake on the pan if left in the heated oven, making cleaning more difficult.

Before broiling, position rack according to the Broiling Chart. Position food on grid in the broiler pan, then place it in the center of the oven rack. Close the door to the broil stop position (about 4" [10.0 cm]) to ensure proper broiling temperature.

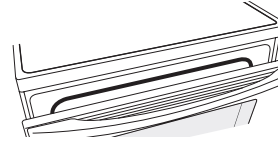

To Broil:

1. Open door to broil stop position.
2. Press upper or lower oven BROIL. “BROIL,” “UPPER” or “LOWER” and “SET” will appear in the display.
3. Press PRESETS once for HI broil or twice for LO broil. “HI” or “LO” will be displayed.
After 4 seconds the oven will start. “BROIL” and “HI” or “LO” will remain in the display.
4. Press CANCEL when finished.

BROILING CHART

Broil times are based on a 4-minute preheat. For best results, place food 3" (7.0 cm) or more from the broil element. Times are guidelines only and may need to be adjusted for individual tastes. Turn meat halfway through cooking time. Recommended rack positions are numbered from the bottom (1) to the top (5). For diagram, see the “Positioning Racks and Bakeware” section.

| FOOD | UPPER OVEN RACK POSITION | LOWER OVEN RACK POSITION | SETTING | UPPER OVEN COOK TIME (minutes) | LOWER OVEN COOK TIME (minutes) |
|--|--------------------------|--------------------------|----------|--------------------------------|--------------------------------|
| Steak 1" (2.5 cm) thick medium | 1 | 4 | HI | 8-11 | 15-19 |
| Ground meat patties 4 oz (113 g), ¾" (2.0 cm) thick up to 12, well-done up to 6, well done | 1 1 | 4 4 | HI HI | 15-20 12-16 | 15-19 15-19 |
| Pork chops 1" (2.5 cm) thick, well-done | 1 | 4 | HI | 18-24 | 22-27 |
| Chicken bone-in, skin-on breast pieces well-done | 1 | 3 or 4 | LO | 25-36 | 28-39 |
| Fish* Filets, flaky Steaks, 1" (2.5 cm) thick, flaky | 1 1 | 4 4 | LO LO | 8-12 10-14 | 8-13 10-16 |

*When broiling fish, spray broil pan with cooking oil. Do not turn fish filets.

Toasting - Upper Oven Only

For toasting bread and products that are toasted in a toaster or toaster oven.

- Lower oven cannot be operated while upper oven is toasting. If the lower oven is operating when the Toast pad is pressed, a beep will sound.
- Toasting is based on time not temperature.
- For more even browning results, preheat the oven 3 to 4 minutes.
- Toasting times will be shorter when the oven is hot or when repeated toasting functions are done.

For optimal results when toasting 4 to 5 pieces of bread or other similar items, see the following illustration.

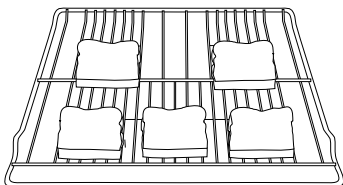

1. Press TOAST.
2. Press PRESETS to set 4 minutes of toasting time. Each additional press will increase the toasting time by 10 seconds.
3. "TOAST" and "UPPER" will be displayed. The toasting time will begin to count down.

OR

Press the appropriate number pads to set the toasting time in minutes and seconds between 10 seconds and 6 minutes.

Example: To set toasting time for 2 minutes, press 2, 0, 0.

Browning time may vary, watch toasting closely to avoid over-browning.
4. Close oven door during toasting.
5. At the end of the set toasting time, the oven will beep 4 times.

Toasting Chart

| FOOD | TOAST TIME* (minutes) COLD START |
|---------------------------|-------------------------------------|
| Sliced white bread | 3½-4½ |
| Waffles (frozen) | 4-4½ |
| Toaster pastry (unfrozen) | 3½-4 |
| Toaster pastry (frozen) | 4½-4¾ |
| Pocket sandwich (frozen) | 4-5 |
| Tortillas (flour) | 2½-3 |
| Bagels | 4½-5 |
| English muffins | 3½-4 |
| Cheese sandwich | 3½-4½ |

*Toasting times are approximate and should be used as a guide only.

Hold Warm Feature

⚠ WARNING

Food Poisoning Hazard

Do not let food sit in oven more than one hour before or after cooking.

Doing so can result in food poisoning or sickness.

IMPORTANT: Food must be at serving temperature before placing it in the warmed oven. Food may be held up to 1 hour; however, breads and casseroles may become too dry if left in the oven during the Hold Warm feature.

The Hold Warm feature allows hot cooked foods to stay at serving temperature. It can also be used at the end of a timed cook.

Follow manufacturer's recommendations when warming empty serving bowls and plates.

To Use:

1. Press appropriate Hold Warm pad.
"WARM," "000," and either UPPER or LOWER flashes in the display.
2. Press PRESETS or number pads to select a temperature.
"170°" will light when Presets is first pressed. Each press of the Presets pad will increase the temperature by 5°.
The Hold Warm temperature can be set from 145°F (63°C) to 190°F (85°C).

"WARM" and the temperature will be displayed while Hold Warm setting is active.

To Cancel Hold Warm Feature:

Press CANCEL. Remove food from oven.

Cook & Hold

⚠ WARNING

Food Poisoning Hazard

Do not let food sit in oven more than one hour before or after cooking.

Doing so can result in food poisoning or sickness.

Cook & Hold allows the oven to be set to cook for a set length of time, followed by a 1-hour Hold Warm cycle.

Delay Cook & Hold allows the oven to be set to start cooking after a length of time you set, cook for a set length of time, followed by a 1-hour Hold Warm cycle.

Delay start should not be used for food such as breads and cakes because they may not bake properly. Do not use delayed baking if oven is already hot.

To Set Cook & Hold:

1. Press COOK & HOLD once for the upper oven and twice for the lower oven. "HOLD," "00:00," and either "UPPER" or "LOWER" will flash in the display.
2. Press the appropriate number pads to select an amount of time to cook. The time selected will show in the display while "HOLD" continues to flash. Time can be set from 10 minutes to 11 hours and 59 minutes.
3. While "HOLD" is still flashing press BAKE.
4. Press PRESETS for 350°F (175°C) or the appropriate number pads to select the oven temperature. The selected function, "000," and either "UPPER" or "LOWER" will flash.
The oven temperature can be set between 170°F and 550°F (75°C and 288°C).
5. Press the selected function pad again or wait 4 seconds.
The selected function will remain lit in the display, and the cooking time will be displayed.

"PREHEAT" will appear in the display. The actual oven temperature will display during preheat. The set temperature will display when preheating is completed.

When the cooking time has elapsed:

Four beeps will sound, "WARM" and "HOLD" will light and "170°" ("75°" Celsius) will appear in the display.

After 1 hour in Hold Warm:

The oven turns off automatically. Press CANCEL when removing food from the oven prior to 1 hour.

To cancel Cook & Hold at any time:

Press CANCEL. Remove food from oven.

To Set a Delayed Cook & Hold cycle:

Before setting, make sure the clock is set to the correct time of day. See "Clock" section.

1. Press DELAY once for the upper oven and twice for the lower oven. "DELAY," "00:00," and "UPPER" or "LOWER" will flash in the display.
2. Press the appropriate number pads to set the length of time you want to delay the cooking time.
3. While "DELAY" is still flashing, press COOK & HOLD. "HOLD," "DELAY," "00:00," and "UPPER" or "LOWER" will flash in the display.
4. Press the appropriate number pads to set the baking time.
Time can be set between 10 minutes and 11 hours and 59 minutes.
5. Press BAKE (upper and lower ovens).
6. Set the oven temperature desired by pressing PRESETS or appropriate number pads.
"350°" ("175°" Celsius) will light when Presets is pressed. After 4 seconds, the entered delay time will appear in the display.

The selected function and "DELAY" remain lit to remind you that a delayed Cook & Hold cycle has been programmed.

When the Delay time has expired:

"DELAY" will turn off. The selected function and the baking time will be displayed. Baking will begin.

When the cooking time has elapsed:

Four beeps will sound, the selected function will turn off and "HOLD," "WARM," and "170°" ("75°" Celsius) will appear in the display.

After 1 hour in Hold Warm:

The oven turns off automatically. Press CANCEL and remove food from the oven.

To cancel:

Press the appropriate CANCEL pad. All timed and untimed cooking functions will be canceled. The time of day will reappear in the display.

Automatic Shutoff/Sabbath Mode

The oven control is set to automatically shut off the oven 12 hours after the oven is turned on. This feature can be turned off to enable Sabbath Mode.

- Sabbath Mode can be turned on at any time with or without the oven on.
- Sabbath Mode cannot be turned on if the touchpads are locked out or when the door is locked.
- If the oven is baking when Sabbath Mode is set, "BAKE" will go out at the end of the baking cycle or when Cancel or Stop is pressed. There will be no audible beeps.
- If the oven light is desired while in Sabbath Mode, it must be turned on before the Sabbath Mode is started.
- When the Sabbath Mode is started, the temperature display will immediately show the set temperature, rather than the actual oven cavity temperature. No preheat beep will sound.
- All prompts, messages and beeps are deactivated when Sabbath Mode is active.
- The self-clean cycle and automatic door lock does not operate during the Sabbath Mode.
- Pressing Cancel will cancel a Bake cycle, however the control will stay in the Sabbath Mode.
- If power fails, the oven will power up in Sabbath Mode with 72 hours remaining and no cycle active.

To cancel the 12-hour shutoff and run the oven continuously for 72 hours (Sabbath Mode):

1. Press and hold CLOCK for 3 seconds.
"Sab bATH" will be displayed and flash for 5 seconds.
"Sab bATH" will then be displayed continuously until turned off or until the 72-hour time limit is reached.
BAKE will also be displayed if a bake cycle is in use while the oven is in Sabbath Mode.
BAKE is the only function that operates during the Sabbath Mode. All function keys (except Cancel, Stop and Clock) are locked out during the Sabbath Mode.

To cancel the Sabbath Mode:

Press and hold CLOCK for 3 seconds. "Sab bATH" will flash for 5 seconds. The time of day will return to the display.

OR

After 72 hours, the Sabbath Mode will end. "Sab bATH" will flash for 5 seconds. The time of day will return to the display.

Favorites

⚠ WARNING

Food Poisoning Hazard

Do not let food sit in oven more than one hour before or after cooking.

Doing so can result in food poisoning or sickness.

The Favorites feature allows you to save the time and temperature from a Cook & Hold Bake function.

To set a Favorites cycle, a Cook & Hold function must be either active or just programmed.

To Set a Favorites Cycle:

1. Program a Cook & Hold cycle as described in the "Cook & Hold" section.
2. Press and hold FAVORITES for 3 seconds.

The newly set or currently running Cook & Hold cycle will be saved.

A double, then single beep will sound to indicate that the control has accepted the Favorites setting.

To Start a Favorites Cycle:

1. Press FAVORITES.

Time and temperature for the set Cook & hold cycle will be displayed. (If no Cook & Hold cycle has been set, "nonE" will be displayed.)

2. Press BAKE.

The Favorites cycle will begin immediately. The selected cycle and cooking time will appear in the display.

When the Cooking Time has Elapsed:

The selected function will turn off and "HOLD," "WARM," and "170°" ("75°" Celsius) will appear in the display.

After 1 hour in Hold Warm:

The oven turns off automatically. If you want to remove food before 1 hour, press CANCEL and remove food from the oven.

To cancel a Favorite cycle:

1. Press CANCEL.

The stored Favorites cycle will not be affected.

2. Remove food from the oven.

RANGE CARE

Self-Cleaning Cycle

⚠ WARNING



Burn Hazard

Do not touch the oven during the Self-Cleaning cycle.

Keep children away from oven during Self-Cleaning cycle.

Failure to follow these instructions can result in burns.

IMPORTANT: The health of some birds is extremely sensitive to the fumes given off during the Self-Cleaning cycle. Exposure to the fumes may result in death to certain birds. Always move birds to another closed and well-ventilated room.

Self-clean the oven before it becomes heavily soiled. Heavy soil results in longer cleaning and more smoke.

Keep the kitchen well-ventilated during the Self-Cleaning cycle to help get rid of heat, odors, and smoke.

Do not block the oven vent(s) during the Self-Cleaning cycle. Air must be able to move freely. Depending on your model, see "Oven Vent" or "Oven Vents" section.

Do not clean, rub, damage or move the oven door gasket. The door gasket is essential for a good seal.

Prepare Oven:

- Remove the broiler pan, grid, cookware and bakeware and, on some models, the temperature probe from the oven.
- Remove oven racks to keep them shiny and easy to slide. See "General Cleaning" section for more information.
- Remove any foil from the oven because it may burn or melt, damaging the oven.
- Hand clean inside door edge and the 1½" (3.8 cm) area around the inside oven cavity frame, being certain not to move or bend the gasket. This area does not get hot enough during self-cleaning to remove soil. Do not let water, cleaner, etc. enter slots on door frame. Use a damp cloth to clean this area.
- Wipe out any loose soil to reduce smoke and avoid damage. At high temperatures, foods react with porcelain. Staining, etching, pitting or faint white spots can result. This will not affect cooking performance.

Prepare Cooktop:

- Remove plastic items from the cooktop because they may melt.

IMPORTANT:

Oven temperature must be below 400°F (205°C) to program a clean cycle.

Only 1 oven can be cleaned at a time.

Both oven doors lock when either oven is being cleaned.

How the Cycle Works

IMPORTANT: The heating and cooling of porcelain on steel in the oven may result in discoloring, loss of gloss, hairline cracks and popping sounds.

Before self-cleaning, make sure the door is completely closed or the door will not lock and the self-cleaning cycle will not begin.

Once the oven has completely cooled, remove ash with a damp cloth. To avoid breaking the glass, do not apply a cool damp cloth to the inner door glass before it has completely cooled.

To stop the self-cleaning cycle at anytime, press CANCEL. If the temperature is too high the oven door will remain locked and “cool” and “locked” will be displayed.

The oven light will not function during the self-cleaning cycle.

The Precise Clean™ self-cleaning cycle is a “one touch” step that uses very high temperatures and dissolves soil to a powdery ash. The Precise Clean™ cycle will automatically determine the length of cleaning time needed based on the number of times the oven has been used since the last self-cleaning cycle. The maximum clean time is 4 hours 30 minutes, and the minimum clean time is 2 hours 30 minutes.

To Self-Clean:

1. Close the oven door.
2. Press PRECISE CLEAN™. “CLEAN,” “SET,” and “UPPER” or “LOWER” will flash in the display.
3. Press PRESETS.

MEd (Medium soil, 3 hours) appears in the display.

If the door is not closed, oven will beep and “door” will appear in the display until the door is closed and the Clean pad is pressed again. If the door is not closed within 30 seconds, the self-cleaning operation will be canceled and the display will return to the time of day.

4. To choose a clean setting other than medium, press PRESETS to scroll through the self-cleaning settings.

HVy (heavy soil, 4 hours)
MEd (medium soil, 3 hours)
LITE (light soil, 2 hours)

Choosing the soil level of the oven automatically programs the self-cleaning time.

5. After 4 seconds, the oven will start cleaning.
“CLEAN” will appear in the display. “LOCK” will flash in the display. Once both the oven doors lock, “LOCK” will remain lit. The cleaning time will count down in the display.

When the self-clean cycle ends:

“LOCK” will turn off approximately 1 hour after the end of the clean cycle. The door can then be opened.

To Delay Start Self-Clean:

Before delay starting the Precise Clean™ cycle, make sure the door is closed completely or it will not lock and the cycle will not begin.

1. Press DELAY once for upper oven or twice for lower oven.
“DELAY,” “00:00,” and “UPPER” or “LOWER” will flash in the display.
2. Using the number pads, enter the amount of time you want to delay the cycle. Delay time can be set from 10 minutes (00:10) to 11 hours and 59 minutes (11:59).
3. Press PRECISE CLEAN™.
“SET” flashes in the display.
4. Press PRESETS.
“MEd” (medium soil level) is displayed.
5. To choose a clean setting other than medium, press the PRESETS to scroll through the self-cleaning settings.

HVy (heavy soil, 4 hours)
MEd (medium soil, 3 hours)
LITE (light soil, 2 hours)

Choosing the soil level of the oven automatically programs the self-cleaning time.

After 4 seconds, “CLEAN,” “DELAY,” and “UPPER” or “LOWER” will light and “LOCK” will flash in the display. When both oven doors lock, “LOCK” will stop flashing and stay lit to show that the oven is set for a delayed clean operation. The delay time is displayed.

To change the delay self-clean time:

1. Press DELAY.
“DELAY” flashes and “00:00” will appear in the display.
2. Press the number pads to enter the amount of time you want to delay the cycle.
After 4 seconds, “CLEAN,” “DELAY,” and “LOCK” will appear in the display to show that the oven is set for a delayed clean operation. The delay time is displayed.

When the self-clean cycle starts:

“DELAY” will turn off, and the clean time will appear in the display.

When the self-clean cycle ends:

“LOCK” will turn off approximately 1 hour after the end of the clean cycle. The door can then be opened.

To Stop Self-Clean Anytime:

Press CANCEL. All words disappear from the display. All functions are canceled. The time of day appears in the display.

Depending on the actual oven temperature when self-clean is canceled, the oven door may remain locked until the oven cools.

General Cleaning

IMPORTANT: Before cleaning, make sure all controls are off and the oven and cooktop are cool. Always follow label instructions on cleaning products.

Soap, water and a soft cloth or sponge are suggested first unless otherwise noted.

EXTERIOR PORCELAIN ENAMEL SURFACES

Food spills containing acids, such as vinegar and tomato, should be cleaned as soon as the entire range is cool. These spills may affect the finish.

Cleaning Method:

- Glass cleaner, mild liquid cleaner or nonabrasive scrubbing pad: Gently clean around the model and serial number plate because scrubbing may remove numbers.
- All-Purpose Appliance Cleaner Part Number 31682 (not included):
See “Assistance or Service” section to order.

STAINLESS STEEL (on some models)

To avoid damage to stainless steel surfaces, do not use soap-filled scouring pads, abrasive cleaners, Cooktop Cleaner, steel-wool pads, gritty washcloths or abrasive paper towels.

Cleaning Method:

Rub in direction of grain to avoid damaging.

- Stainless Steel Cleaner and Polish Part Number 31462 (not included): See “Assistance or Service” section to order.
- Liquid detergent or all-purpose cleaner: Rinse with clean water and dry with soft, lint-free cloth.

CERAMIC GLASS (on some models)

To avoid damage to the cooktop, do not use steel wool, abrasive powder cleansers, chlorine bleach, rust remover or ammonia.

Cleaning Method:

Always wipe with a clean, wet cloth or sponge and dry thoroughly to avoid streaking and staining.

Cooktop Cleaner Part Number 31464 is recommended regularly to help avoid scratches, pitting and abrasions and to condition the cooktop, and can be ordered as an accessory. See “Assistance or Service” section to order.

Cooktop Scraper Part Number WA906B is also recommended for stubborn soils, and can be ordered as an accessory. See “Assistance or Service” section to order. The Cooktop Scraper uses razor blades. Store razor blades out of the reach of children.

Light to moderate soil

- Paper towels or clean damp sponge

Sugary spills (jellies, candy, syrup)

- Cooktop Scraper:
Scrape off sugary spills while the cooktop is still warm. You may want to wear oven mitts while cleaning the cooktop.
- Cooktop Polishing Creme and clean damp paper towel:
Clean as soon as cooktop has cooled down. Rub creme into surface with a damp paper towel or soft cloth. Continue rubbing until white film disappears.

Heavy soil, dark streaks, specks and discoloration

- Cooktop Polishing Creme or nonabrasive cleanser:
Clean as soon as cooktop has cooled down. Rub product into soil with a damp paper towel or soft cloth. Continue rubbing until white film disappears.

Burned-on soil

Cooktop Cleaner and Cooktop Scraper:

Clean as soon as cooktop has cooled down. Rub creme into soil with damp paper towel. Hold scraper as flat as possible on surface and scrape. Repeat for stubborn spots. Polish entire cooktop with creme and paper towel.

Metal marks from aluminum and copper

- Cooktop Cleaner:
Clean as soon as cooktop has cooled down. Rub creme into surface with a damp paper towel or soft cloth. Continue rubbing until white film disappears. The marks will not totally disappear, but after many cleanings they will become less noticeable.

Tiny scratches and abrasions

- Cooktop Cleaner:
Clean as soon as cooktop has cooled down. Rub creme into surface with a damp paper towel or soft cloth. Continue rubbing until white film disappears. Scratches and abrasions do not affect cooking performance, and after many cleanings they will become less noticeable.

COOKTOP CONTROLS

To avoid damage to the cooktop controls, do not use steel wool, abrasive cleansers or oven cleaner.

To avoid damage, do not soak knobs.

When removing or replacing knobs, make sure knobs are in the Off position.

Do not remove seals under knobs, if present.

Cleaning Method:

- Warm, soapy water: Pull knobs straight away from control panel to remove.

CONTROL PANEL

To avoid damage to the control panel, do not use abrasive cleaners, steel-wool pads, gritty washcloths or abrasive paper towels.

To avoid turning the controls on while cleaning, you may activate the Control Lock feature (on some models). See “Oven Door and Control Lockout” section.

Cleaning Method:

- Glass cleaner and soft cloth or sponge: Apply glass cleaner to soft cloth or sponge, not directly on panel.
- All-Purpose Appliance Cleaner Part Number 31682 (not included):
See “Assistance or Service” section to order.

OVEN DOOR EXTERIOR

Cleaning Method:

- Glass cleaner and paper towels or nonabrasive plastic scrubbing pad: Apply glass cleaner to soft cloth or sponge, not directly on panel.
- All-Purpose Appliance Cleaner Part Number 31682 (not included):
See "Assistance or Service" section to order.

OVEN CAVITY

Do not use oven cleaners.

Food spills should be cleaned when oven cools. At high temperatures, foods react with porcelain and staining, etching, pitting or faint white spots can result.

Cleaning Method:

- Self-Cleaning cycle: See "Self-Cleaning Cycle" first.

OVEN RACKS

Cleaning Method:

- Self-Cleaning cycle: See "Self-Cleaning Cycle" first. Remove racks, or they will discolor and become harder to slide. If this happens, a light coating of vegetable oil applied to the rack guides will help them slide.
- Steel-wool pad

Oven Lights

The ovens use either a 120-volt, 20-watt maximum halogen bulb and/or a standard 40-watt appliance bulb.

To Replace Standard Oven Light:

Before replacing, make sure the oven is off and cool.

1. Unplug range or disconnect power.
2. Turn the glass bulb cover in the back of the oven counterclockwise to remove.

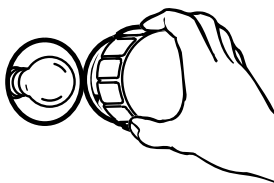

3. Turn bulb counterclockwise to remove from socket.
4. Replace bulb and bulb cover by turning clockwise.
5. Plug in range or reconnect power.

To Replace Halogen Light:

Before replacing, make sure the oven is off and cool.

1. Unplug range or disconnect power.
2. Use fingertips to grasp edge of bulb cover. Pull out and remove.

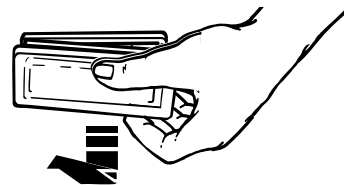

3. Remove bulb from socket by pulling straight out of the ceramic base.
4. Replace bulb using a tissue or wearing clean cotton gloves to handle bulb. To avoid damage to or decreasing the life of the new bulb, do not touch bulb with bare fingers.
5. Replace bulb cover by snapping back into place.
6. Plug in range or reconnect power.

Oven Door

For normal range use, it is not suggested to remove the oven door. However, if removal is necessary, make sure the oven is off and cool. Then, follow these instructions. The oven door is heavy.

To Remove:

1. Open oven door to the first stop position (opened about 4" [10.0 cm]).
2. Grasp door at each side. Do not use the door handle to lift door.
3. Lift up evenly until door clears hinge arms.

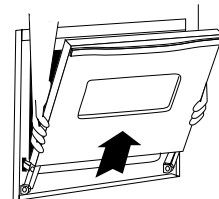

To Replace:

1. Grasp door at each side.
2. Align slots in the door with the hinge arms on the range.
3. Slide the door down onto the hinge arms until the door is completely seated on the hinges. Push down on the top corners of the door to completely seat door on hinges. Door should not appear crooked.

TROUBLESHOOTING

Try the solutions suggested here first in order to avoid the cost of an unnecessary service call.

Nothing will operate

- **Has a household fuse blown, or has a circuit breaker tripped?** Replace the fuse or reset the circuit.
-

Cooktop will not operate

- **Is the control knob set correctly?** Push in knob before turning to a setting.
-

Excessive heat around cookware on cooktop

- **Is the cookware the proper size?** Use cookware about the same size as the surface cooking area, element or surface burner. Cookware should not extend more than ½" (1.3 cm) outside the cooking area.
-

Hot Surface indicator light stays on (on some models)

- **Does the Hot Surface indicator light stay on after control knob(s) have been turn off?** See "Cooktop Controls" section.
-

Cooktop cooking results not what expected

- **Is the proper cookware being used?** See "Cookware" section.
 - **Is the control knob set to the proper heat level?** See "Cooktop Controls" section.
 - **Is the range level?** Level the range. See the Installation Instructions.
-

Oven will not operate

- **Is the electronic oven control set correctly?** See "Electronic Oven Controls" section.
 - **Has a delay start been set?** See "Cook & Hold" section.
 - **On some models, is the Control Lock set?** See "Oven Door and Control Lockout" section.
-

Oven temperature too high or too low

- **Does the oven temperature calibration need adjustment?** See "Oven Temperature Control" section.
 - **On some models, does the cooling fan run during Bake, Broil or Clean?**
It is normal for the fan to automatically run when the oven is in use. This helps cool the electronic control.
-

Oven indicator lights flash

- **Do the oven indicator lights flash?** See the "Electronic Oven Controls" section. If the indicator light(s) keeps flashing, call for service. See "Assistance or Service" section to order.
-

Display shows messages

- **Is "BAKE" or "LOCK" flashing in the display?** There has been a power failure. Clear the display. See "Display" section. Reset the clock, if needed. See "Clock" section. If it reappears, call for service. See "Assistance or Service" section to order.
-

Self-Cleaning Cycle will not operate

- **Is the oven door open?** Close the oven door all the way.
 - **Has the function been entered?** See "Self-Cleaning Cycle" section.
 - **Has a delay start Self-Clean cycle been set?** See "Self-Cleaning Cycle" section.
 - **Has a delay start been set?** See "Cook & Hold" section.
-

Oven cooking results not what expected

- **Is the range level?** Level the range. See the Installation Instructions.
- **Is the proper temperature set?** Double-check the recipe in a reliable cookbook.
- **Is the proper oven temperature calibration set?** See "Oven Temperature Control" section.
- **Was the oven preheated?** See "Baking" and "Broiling" sections.
- **Is the proper bakeware being used?** See "Bakeware" section.
- **Are the racks positioned properly?** See "Positioning Racks and Bakeware" section.
- **Is there proper air circulation around bakeware?** See "Positioning Racks and Bakeware" section.
- **Is the batter evenly distributed in the pan?** Check that batter is level in the pan.
- **Is the proper length of time being used?** Adjust cooking time.
- **Has the oven door been opened while cooking?** Oven peeking releases oven heat and can result in longer cooking times.
- **Are baked items too brown on the bottom?** Move rack to higher position in the oven.
- **Are pie crust edges browning early?** Use aluminum foil to cover the edge of the crust.

ASSISTANCE OR SERVICE

Before calling for assistance or service, please check “Troubleshooting.” It may save you the cost of a service call. If you still need help, follow the instructions below.

When calling, please know the purchase date and the complete model and serial number of your appliance. This information will help us to better respond to your request.

If you need replacement parts

If you need to order replacement parts, we recommend that you use only FSP® replacement parts. FSP® replacement parts will fit right and work right because they are made with the same precision used to build every new WHIRLPOOL® appliance.

To locate FSP® replacement parts in your area, call us or your nearest Whirlpool designated service center.

In the U.S.A.

Call the Whirlpool Customer eXperience Center toll free: **1-800-253-1301**.

Our consultants provide assistance with:

- Features and specifications on our full line of appliances.
- Installation information.
- Use and maintenance procedures.
- Accessory and repair parts sales.
- Specialized customer assistance (Spanish speaking, hearing impaired, limited vision, etc.).
- Referrals to local dealers, repair parts distributors and service companies. Whirlpool designated service technicians are trained to fulfill the product warranty and provide after-warranty service, anywhere in the United States.

To locate the Whirlpool designated service company in your area, you can also look in your telephone directory Yellow Pages.

For further assistance

If you need further assistance, you can write to Whirlpool Corporation with any questions or concerns at:

Whirlpool Brand Home Appliances
Customer eXperience Center
553 Benson Road
Benton Harbor, MI 49022-2692

Please include a daytime phone number in your correspondence.

Accessories

Accessories U.S.A.

To order accessories, call the Whirlpool Customer eXperience Center toll free at **1-800-442-9991** and follow the menu prompts. Or visit our website at **www.whirlpool.com** and click on “Parts & Accessories.”

Accessories

Broiler Pan and Grid

Order Part Number 4396923

Stainless Steel Cleaner and Polish

(stainless steel models)

Order Part Number 31462

All-Purpose Appliance Cleaner

Order Part Number 31682

Cooktop Scraper

(ceramic glass models)

Order Part Number WA906B

WHIRLPOOL CORPORATION MAJOR APPLIANCE WARRANTY

LIMITED WARRANTY

For one year from the date of purchase, when this major appliance is operated and maintained according to instructions attached to or furnished with the product, Whirlpool Corporation or Whirlpool Canada LP (hereafter "Whirlpool") will pay for Factory Specified Parts and repair labor to correct defects in materials or workmanship. Service must be provided by a Whirlpool designated service company. This limited warranty is valid only in the United States or Canada and applies only when the major appliance is used in the country in which it was purchased. Outside the 50 United States and Canada, this limited warranty does not apply. Proof of original purchase date is required to obtain service under this limited warranty.

ITEMS EXCLUDED FROM WARRANTY

This limited warranty does not cover:

1. Service calls to correct the installation of your major appliance, to instruct you on how to use your major appliance, to replace or repair house fuses, or to correct house wiring or plumbing.
2. Service calls to repair or replace appliance light bulbs, air filters or water filters. Consumable parts are excluded from warranty coverage.
3. Repairs when your major appliance is used for other than normal, single-family household use or when it is used in a manner that is contrary to published user or operator instructions and/or installation instructions.
4. Damage resulting from accident, alteration, misuse, abuse, fire, flood, acts of God, improper installation, installation not in accordance with electrical or plumbing codes, or use of consumables or cleaning products not approved by Whirlpool.
5. Cosmetic damage, including scratches, dents, chips or other damage to the finish of your major appliance, unless such damage results from defects in materials or workmanship and is reported to Whirlpool within 30 days from the date of purchase.
6. Any food loss due to refrigerator or freezer product failures.
7. Costs associated with the removal from your home of your major appliance for repairs. This major appliance is designed to be repaired in the home and only in-home service is covered by this warranty.
8. Repairs to parts or systems resulting from unauthorized modifications made to the appliance.
9. Expenses for travel and transportation for product service if your major appliance is located in a remote area where service by an authorized Whirlpool servicer is not available.
10. The removal and reinstallation of your major appliance if it is installed in an inaccessible location or is not installed in accordance with published installation instructions.
11. Major appliances with original model/serial numbers that have been removed, altered or cannot be easily determined. This warranty is void if the factory applied serial number has been altered or removed from your major appliance.

The cost of repair or replacement under these excluded circumstances shall be borne by the customer.

DISCLAIMER OF IMPLIED WARRANTIES; LIMITATION OF REMEDIES

CUSTOMER'S SOLE AND EXCLUSIVE REMEDY UNDER THIS LIMITED WARRANTY SHALL BE PRODUCT REPAIR AS PROVIDED HEREIN. IMPLIED WARRANTIES, INCLUDING WARRANTIES OF MERCHANTABILITY OR FITNESS FOR A PARTICULAR PURPOSE, ARE LIMITED TO ONE YEAR OR THE SHORTEST PERIOD ALLOWED BY LAW. WHIRLPOOL SHALL NOT BE LIABLE FOR INCIDENTAL OR CONSEQUENTIAL DAMAGES. SOME STATES AND PROVINCES DO NOT ALLOW THE EXCLUSION OR LIMITATION OF INCIDENTAL OR CONSEQUENTIAL DAMAGES, OR LIMITATIONS ON THE DURATION OF IMPLIED WARRANTIES OF MERCHANTABILITY OR FITNESS, SO THESE EXCLUSIONS OR LIMITATIONS MAY NOT APPLY TO YOU. THIS WARRANTY GIVES YOU SPECIFIC LEGAL RIGHTS, AND YOU MAY ALSO HAVE OTHER RIGHTS WHICH VARY FROM STATE TO STATE OR PROVINCE TO PROVINCE.

If outside the 50 United States and Canada, contact your authorized Whirlpool dealer to determine if another warranty applies.

If you need service, first see the "Troubleshooting" section of the Use & Care Guide. After checking "Troubleshooting," you may find additional help by checking the "Assistance or Service" section or by calling Whirlpool. In the U.S.A., call **1-800-253-1301**. In Canada, call **1-800-807-6777**.

9/07

Keep this book and your sales slip together for future reference. You must provide proof of purchase or installation date for in-warranty service.

Write down the following information about your major appliance to better help you obtain assistance or service if you ever need it. You will need to know your complete model number and serial number. You can find this information on the model and serial number label located on the product.

Dealer name _____

Address _____

Phone number _____

Model number _____

Serial number _____

Purchase date _____

Notes

W10253434A

© 2009 Whirlpool Corporation.
All rights reserved.

© Registered Trademark/TM Trademark of Whirlpool, U.S.A.

5/09
Printed in U.S.A.